

Specification

Integrated Furniture Lighting

LS0812



LS0812

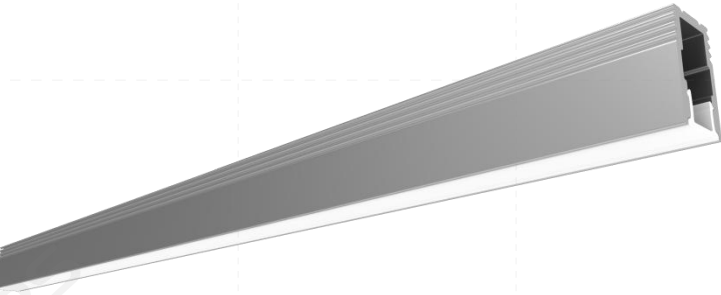

Example of application: wooden decorative board on the wall

Cutout:W8.5*D13mm fixed by glass cement



Features

DLS1.0, a special local auxiliary lighting system, can be widely used in various interior decoration scenarios and local light spaces. A touch of auxiliary decorative lighting in addition to the basic lighting creates different atmospheres and visual enjoyment.

Embellish life with light that follows you whenever you go.

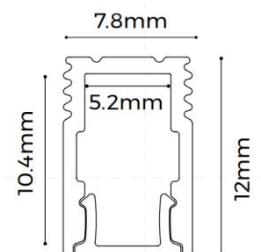

- 1、 “Dots-free”lighting
Perfect homogenous lighting.
- 2、 Various diffuser options
Several options of diffusers, In various shapes and light distribution plans Complete with everything needed
- 3、 “Two” end caps
Two options of end cap for two ways of wire outgoing, Close-fitting design without screws makes installation much easier
- 4、 Various installation methods
A wide range of installation accessories wider applications
- 5、 “One” cut.
Consistent length between diffuser and profile
- 6、 Smart control for unlimited possibilities
Perfectly match the profiles like customized, Control by hand sweep or touching

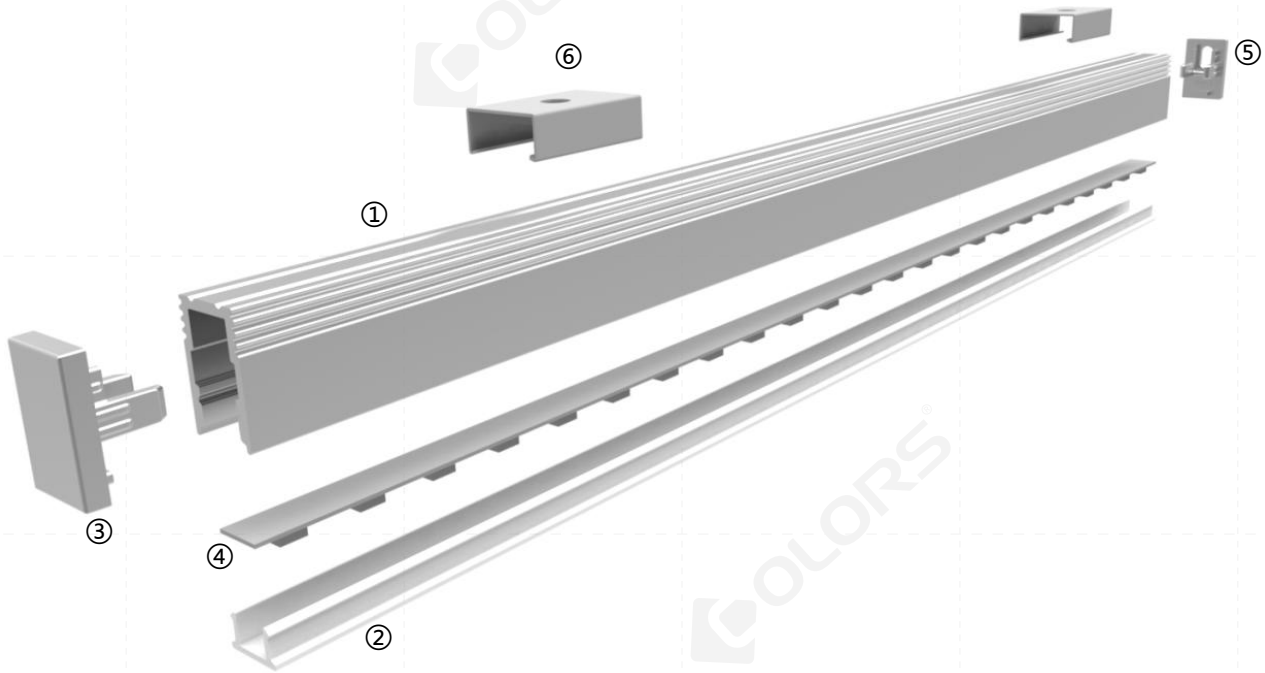

Details







Standard Configuration

| Picture | Item | Parameter | Model |
|-------------------------------------------------------------------------------------|-----------|------------------------------------------------------------------------------------------------------------------------------------------------------------|-----------|
|  | ①Profile | Material: AL6063-T5 Profile weight: 0.2kg/2.5m Size: L2500*W8*H12mm Surface processing: Silver alkali sand oxidation film | / |
|  | ②Cover | Type: Frosted diffuser Material: PC Light transmittance: 55% Size: L2500*W6.4*H3.7mm (shrink) 0.8mm/m when the temperature rises (drops) 10°C. | / |
|  | ③End caps | Size: L12*W7.8*H8mm | EC-LS0812 |



Optional Accessories

| Picture | Item | Parameter | Model |
|-----------------------------------------------------------------------------------|-----------------------------|-------------------------------------------------------------------------------------------------------------------------------------------------------|----------------|
|  | ②Black Cover | Type: Black diffuser Material: PC Light transmittance: 15% Size: L2500*W6.4*H3.7mm (shrink) 0.8mm/m when the temperature rises (drops) 10°C. | CV-LR0812 |
|  | ④FPC strip D6140-24V-4mm | Material: FPC, CCT: 2700/3000/4000/6000K; Ra > 90; Voltage:24V; Power: 6.6W/m; Lumen: 710Lm/m; PCB width: 4mm; Minimum cut: 50mm; | D6140-24V- 4mm |
|  | ⑤End cap with hole | Size: L12*W7.8*H8mm | EC-LS0812 |
|  | ⑥Recessed clips | Size: L15*W9.2*H4.5mm | CP-03 |

Optical Parameter

The testing result of 1M luminaire (with " D6140-24V-4mm " and diffuser)

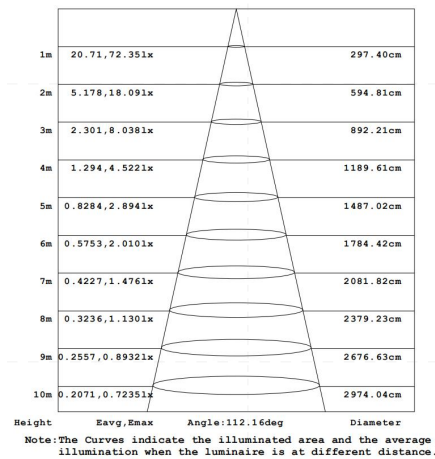
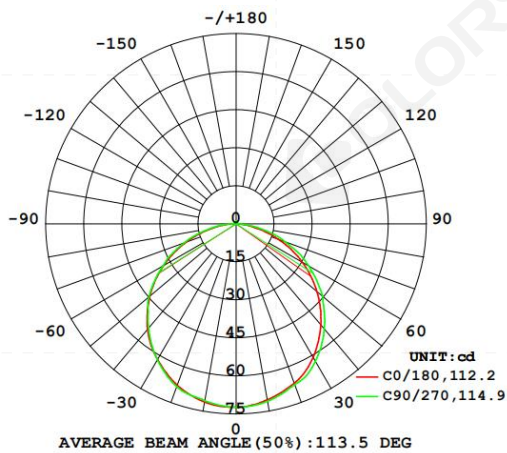

Package

Mode 1 :

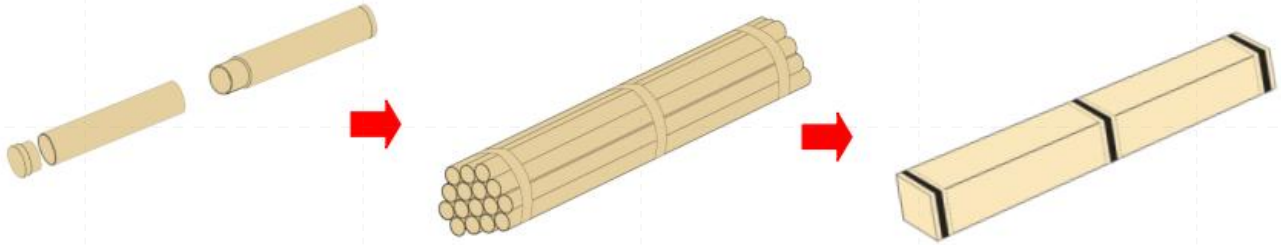

Mode 2 :

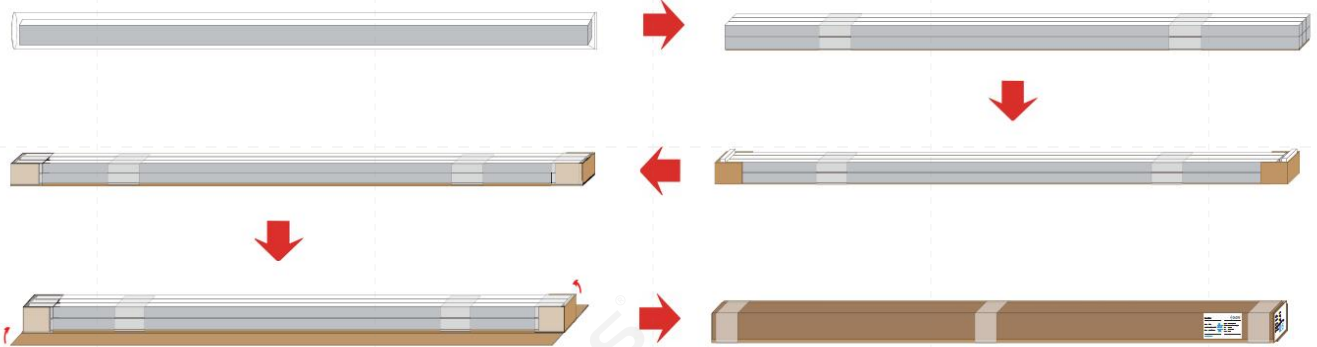

| Components | Packaging material | Size(mm) | NW(kg) | GW(kg) | Content |
|---------------------|--------------------|----------------|--------|--------|-----------|
| Single piece | Hat box | Φ22mm*2580mm | 0.24 | 0.51 | 1pcs/box |
| Whole bundle | Hat box | 2580*250*165mm | 15.12 | 34.13 | 63pcs/box |
| Whole box packaging | Paper box | 2580*95*100mm | 10.8 | 13.8 | 45pcs/box |

